

## Brainboxes US Range Product Manual



---

## Contents

1.	Introduction.....	4
1.1	The US Range.....	4
1.2	Boost.Software driver.....	4
1.3	Supported Operating Systems.....	4
2.	Installation Information for Windows Operating Systems.....	6
2.1	Windows Vista, XP and Windows 7 installation.....	7
2.2	Windows 8 installation.....	10
2.3	Linux installation.....	12
2.2	MAC installation.....	15
2.3	Finding your Brainboxes COM port.....	19
2.4	Port Settings.....	19
2.5	Changing your COM label.....	21
3.	RS-232 Settings (US-101, US-235, US-257, US-279, US-701).....	23
3.1	The RS-232 Standard.....	23
3.2	9 Pin D Serial Port RS-232 Cables.....	23
3.3	9 Pin D serial port connections to another PC.....	23
4.	RS-422/485 Settings (US-320, US-324, US-313, US-346, and US-842 only).....	25
4.1	The RS-422 Standard.....	26
4.2	The RS-485 Standard.....	26
4.3	Terminating Impedances.....	27
4.4	Fail Safe Open Circuit Detection.....	28
4.5	Fail Safe Short Circuit Detection.....	28
4.6	RS-422 Operation.....	28
4.7	RS-485 Operation.....	28
4.8	RS-422 Serial Port Cables.....	30
4.9	RS-485 Serial Port Cables.....	30
4.10	Optional Grounding Arrangements.....	30
5.	Advanced Settings – USB Settings.....	32
6.	Uninstallation.....	34

6.1	Uninstalling in Windows XP .....	34
6.2	Uninstalling in Windows Vista / Windows 7 .....	34
6.3	Boost.Software Uninstaller .....	35
7.	Boost.Software US Card Driver Upgrade / Rollback .....	36
7.1	Upgrading the Boost.Software Driver .....	36
8.	Troubleshooting and Testing .....	37
8.1	Installation problems .....	37
8.2	Communication Problems .....	37
9.	Lifetime Warranty and Support .....	38
10.	Technical Specifications .....	39
10.1	Supported Serial Settings .....	39
10.2	Device Pinout .....	39
10.3	USB Connector Pinouts .....	40
10.4	Storage and Operating Environment Guidelines .....	41
10.5	RS-422/485 bias/terminating resistors - applicable to US-324/313/346/842 only .....	41
11.	Regulatory Approvals / Compliance .....	42
11.1	Company Accreditation .....	42
11.2	Europe – EU Declaration of Conformity .....	42
11.3	WEEE Directive (Waste Electrical and Electronic Equipment).....	42
11.4	RoHS Compliance .....	43
12.	Copyright .....	43

## 1. Introduction

### 1.1 The US Range

The US range includes 1, 2, 4, and 8 port devices which will provide an RS-232 or RS-422/485 9-pin COM port to any device with a USB slot.

With large FIFO buffers, the US range offers high data rates of up to 1 Megabaud, making high speed serial communications “a breeze” for your system.



### 1.2 Boost.Software driver

Brainboxes Boost.Software drivers have undergone Microsoft testing with the US Range. Upon passing these tests, the drivers were signed by Microsoft, as an indication of their quality and stability.

Boost.Software is the device driver for managing the US range from Windows. For a full list of supported Operating Systems, please see the list below.

### 1.3 Supported Operating Systems

The US Range can be used in the following Microsoft Operating Systems with the supplied drivers;



Brainboxes Boost Software drivers have undergone Microsoft testing with the US-Range. Upon passing these tests, the drivers were signed by Microsoft, as an indication of their quality and stability.

## 2. Installation Information for Windows Operating Systems

### PLEASE READ CAREFULLY

- The Setup.exe program will install all the driver files required to guarantee a smooth and straightforward installation
- Please ensure all Brainboxes devices are disconnected before starting the installation program.
- If any previous Brainboxes Boost.Software drivers are found, you will be notified on what action to take.
- Follow the instructions below to start the installation process.

**If you have any issues with installation, please follow the steps in Section 6: Uninstallation, then attempt to install again. If you still have issues, see Section 8: Troubleshooting and Testing**

## 2.1 Windows Vista, XP and Windows 7 installation

1. With the laptop turned on, insert the CD
2. If the CD does not autorun, Go to Start → My Computer → Right Click the CD and select Explore. This will open the CD in Windows Explorer for browsing the contents of the CD.
3. Locate the “Setup.exe” program on the CD and double click to launch.
4. Ensure all US Card devices are REMOVED before proceeding. Otherwise installation may not complete successfully.
5. Click Next

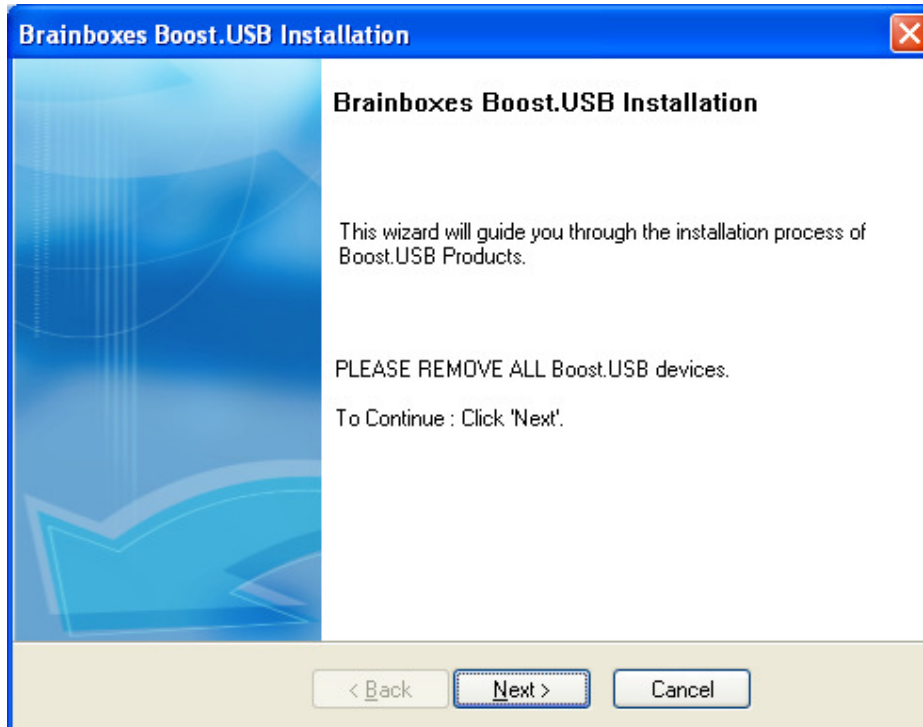

6. The drivers will then be installed. This may take a while, depending on your system.

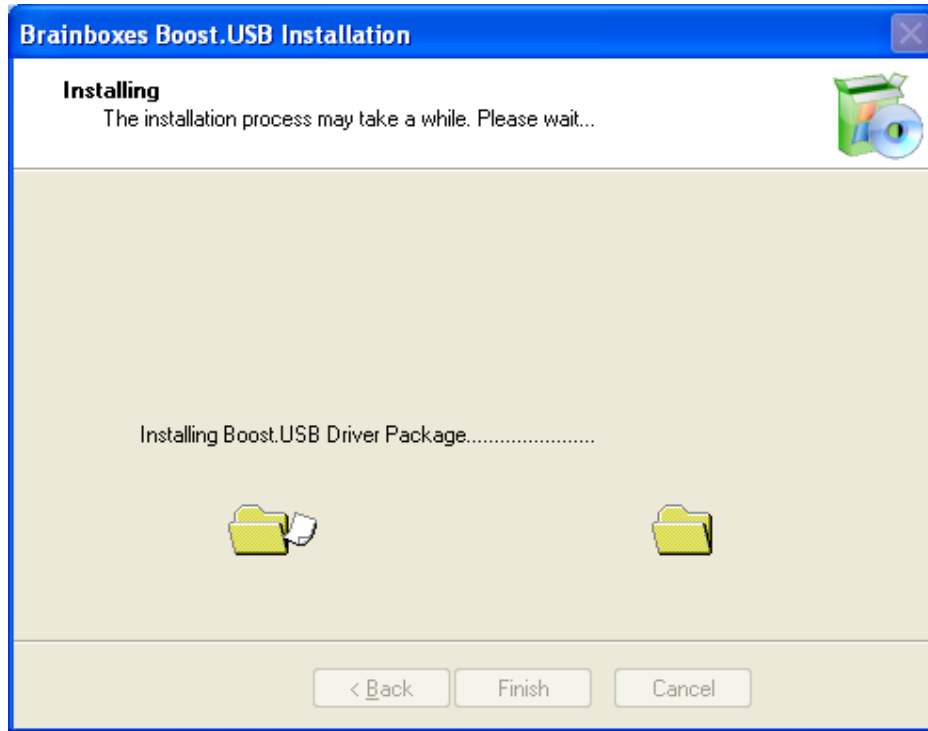

7. Installation Complete. Click Finish.

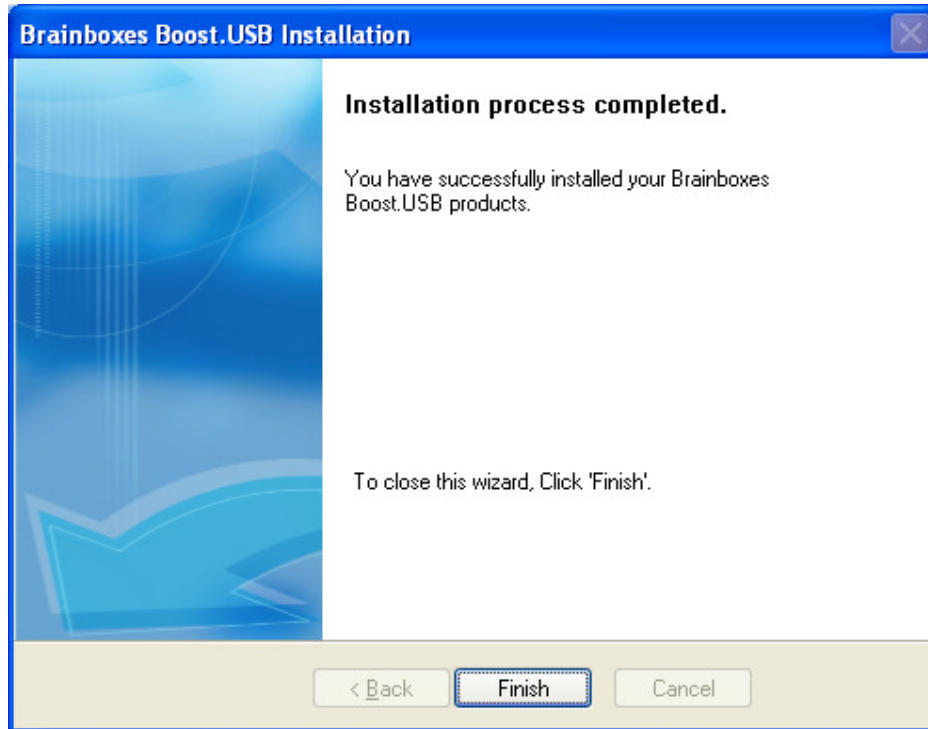



8. Insert your US Product (s).

9. Pop up balloons will appear as the device is recognised by the preinstalled drivers. The example below is for a US-101, and may differ slightly per product.



10. Once installation is complete (indicated by last balloon above), your device will now be ready to use.

11. You can check the COM Number of the Port, by opening Device Manager (See **Section 2.4: Finding your Brainboxes COM port**). If you need to change the COM port number, see **Section 2.6 Changing Your COM Label**.

## 2.2 Windows 8 installation

1. With the laptop turned on, insert the CD and you will now see this window appear in the top right-hand corner of the screen.

If the CD does not autorun, Go to Start → My Computer → Right Click the CD and select Explore. This will open the CD in Windows Explorer for browsing the contents of the CD.

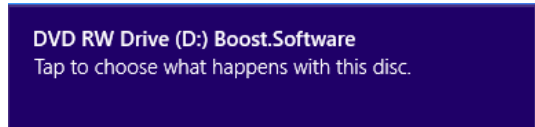

2. When you have clicked on the pop-up screen as shown above, you will then see an option to view the folders on the disc. Please click on this to view the driver files.

### DVD RW Drive (D:) Boost.S...

Choose what to do with this disc.

#### Install or run program from your media





















 Run README.htm  
Publisher not specified

#### Other choices

 Open folder to view files  
File Explorer

 Take no action

3. Locate the “Setup.exe” program on the CD and double click to launch.

 Adobe	30/03/2012 11:29	File folder	
 Dlls	30/03/2012 11:29	File folder	
 drivers	30/03/2012 11:29	File folder	
 Exes	30/03/2012 11:29	File folder	
 Help	30/03/2012 11:29	File folder	
 Product Information	30/03/2012 11:29	File folder	
 Product Support	30/03/2012 11:29	File folder	
 Uninstall	30/03/2012 11:29	File folder	
 autorun	27/03/2012 16:38	Setup Information	1 KB
 BB	03/03/2006 16:13	Icon	3 KB
 bblogo	26/03/2012 16:46	JPG File	41 KB
 bbubus	23/03/2012 17:18	Security Catalog	17 KB
 BbUBus	19/03/2012 14:17	Setup Information	31 KB
 bbuser	23/03/2012 17:18	Security Catalog	17 KB
 BbUSer	19/03/2012 14:17	Setup Information	10 KB
 README	30/03/2012 11:24	Chrome HTML Do...	14 KB
 README	27/03/2012 16:37	Text Document	3 KB
 Revision	19/03/2012 14:29	Text Document	1 KB
 SerialTest	09/05/2008 10:30	Application	474 KB
 Setup	19/03/2012 14:29	Application	605 KB

4. Click on the Setup.exe file (bottom of the picture above). This will begin the installation of the drivers. When you click on this file, you will then see this picture.

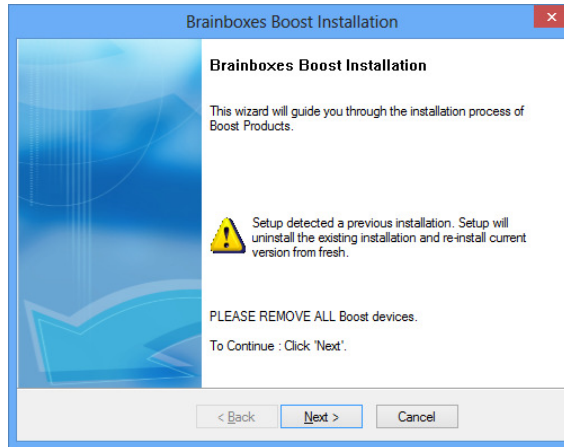

5. When you have clicked on the Next button, you will then see the drivers start to install and when they have finished installing, you will see a window like this.

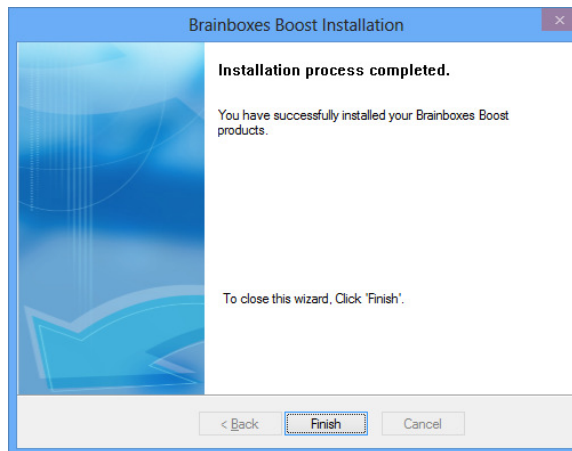

6. Now that the drivers have installed, go to Device Manager and find your Brainboxes USB2Serial device in there. It should have a COM port number next to it for you to select in your application.

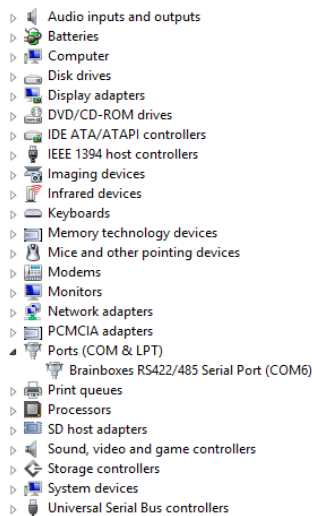

## 2.3 Linux installation

There are 2 methods to install US/VX devices in a Linux system. Start from kernel 2.6.14, it includes a module called `ftdi_sio` which supports our US/VX chipset. We can use build in `ftdi_sio` (if standard distro) (method 1) or we can rebuild kernel or kernel module (method 2).

Method 1 is an easy method, but it's restricted to only one device (1 and 2 port device only) at a time unless you restart or unload/reload the `ftdi_sio` module.

Method 2 is more technical because it involves re-building the kernel module or kernel. It will also support multiple devices in the system as well as 4 and 8 port US/VX device.

### Method 1 (Easier method)

Use this method if you have only one US or VX device and want to use with Linux (kernel version 2.6.14 or later).

- Open a terminal window in Linux
- Copy "99-bbftdisio.rules" files to `/etc/udev/rules.d` directory.
- e.g: `sudo cp /home/TestUser/Desktop/diskimage/99-bbftdisio.rules /etc/udev/rules.d`
- Where `"/home/TestUser/Desktop/diskimage/"` is the location of "99-bbftdisio.rules" file.
- Restart your system.
- After system restart, plug in your US or VX device.
- Open a terminal window in Linux again.
- Use `lsusb <CR>` to confirm Linux recognize the system

### Method 2

This method is a bit difficult but it will work with multiple devices plugged into the Linux system.

**Prerequisite:** Need kernel build tools on your system to build the Linux kernel or module.

To build the patch kernel module, generally you need to perform the following steps:

1. Setup Kernel development package and tools
2. Download kernel source
3. Patch `ftdi_sio` files. 'ftdi\_sio.patch' and 'ftdi\_sio\_ids.patch' are to patch the Linux kernel 2.6.x `ftdi_sio` module source.
4. Build the kernel module.
5. Copy Module to the Linux model system and load the module.

Please follow the steps below to build the module (the following examples use Ubuntu 10.10)

**Get the Linux kernel source.**

```
sudo apt-get install aptitude<CR>
sudo apt-get install patch<CR>
export KERNEL_VERSION=`uname -r|cut -d '-' -f 1`<CR>
sudo aptitude install linux-source- $\$$ KERNEL_VERSION<CR>
cd /usr/src<CR>
sudo tar jxf linux-source- $\$$ KERNEL_VERSION.tar.bz2<CR>
sudo ln -s linux-source- $\$$ KERNEL_VERSION linux<CR>
sudo ln -s /usr/src/linux/lib/modules/`uname -r`/build<CR>
cd linux<CR>
```

**Prepare the build system**

```
sudo cp /boot/config-`uname -r` /usr/src/linux/.config<CR>
cd linux<CR>
sudo make oldconfig<CR>
sudo make prepare0<CR>
sudo make scripts<CR>
sudo make modules_prepare<CR>
sudo cp /lib/modules/2.6.35-22-generic/kernel/drivers/usb/serial/ftdi_sio.ko /lib/modules/2.6.35-22-generic/kernel/drivers/usb/serial/ftdi_sio.ko_backup<CR>
```

**Patch and Build the 'ftdi\_sio' module. 'ftdi\_sio.patch' and 'ftdi\_sio\_ids.patch' are to patch the Linux kernel 2.6.x ftdi\_sio module source. The following example show building a single 'ftdi\_sio' module. You can also rebuild the whole kernel system.**

```
sudo patch /usr/src/linux/drivers/usb/serial/ftdi_sio.c < /home/bandu/Downloads/ftdi_sio.patch<CR>
sudo patch /usr/src/linux/drivers/usb/serial/ftdi_sio_ids.h < /home/bandu/Downloads/ftdi_sio_ids.patch<CR>
sudo make -C /lib/modules/`uname -r`/build M=`pwd` drivers/usb/serial/ftdi_sio.ko<CR>
```

**Copy Module to the Linux model system and load the module.**

```
sudo cp /usr/src/linux/drivers/usb/serial/ftdi_sio.ko /lib/modules/2.6.35-22-  
generic/kernel/drivers/usb/serial/<CR>
```

```
sudo rmmod ftdi_sio<CR>
```

```
sudo modprobe ftdi_sio<CR>
```

**(Optional) Prepare module to load every time at start up. You need to append 'ftdi\_sio' (exclude "'") string at /etc/modules file.**

## 2.2 MAC installation

Copy “BrainboxesUSB2Serial.pkg” to a folder on your Mac and open it

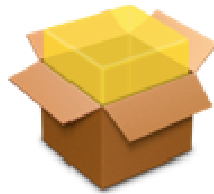

BrainboxesUSB2Serial

Click *Continue* on the introduction page.

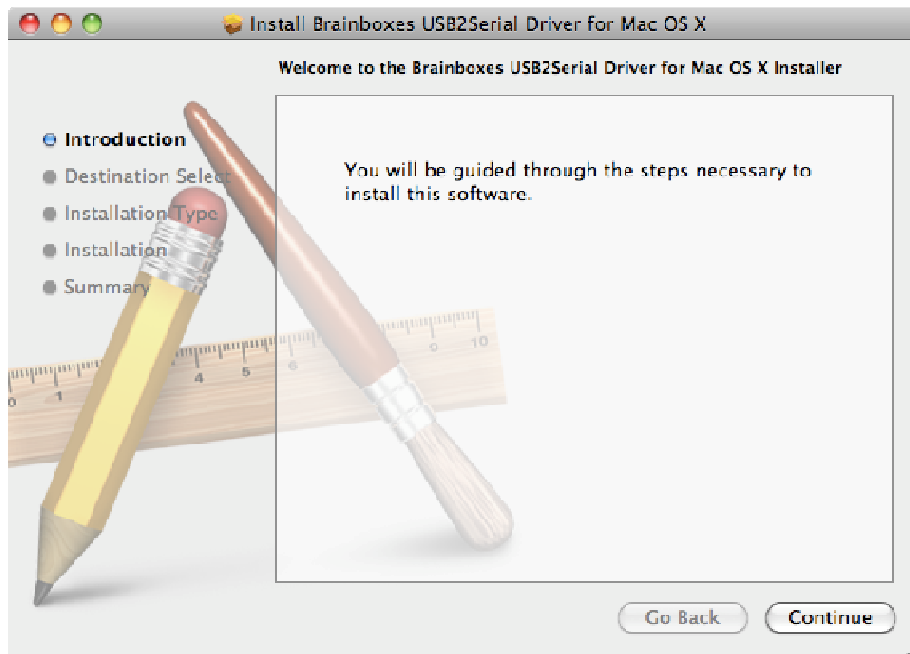

Select the disk which you want the Brainboxes driver to be installed



Click the *Install* button to start the installation process.

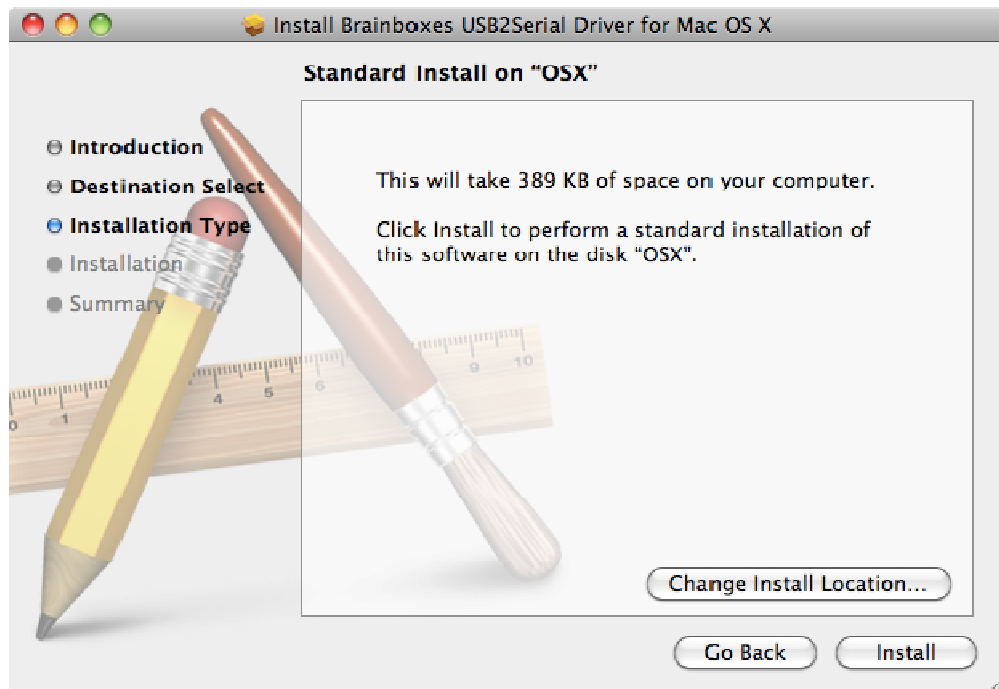



Enter your password if you are prompted.

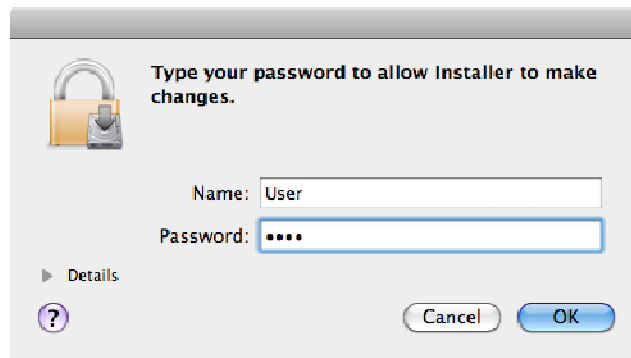

You will then see a message box telling you a restart is required once the installation completes

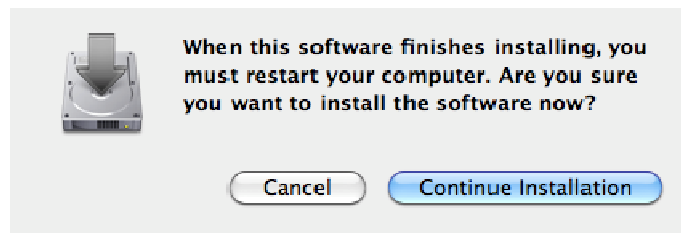

The driver will then be installed.

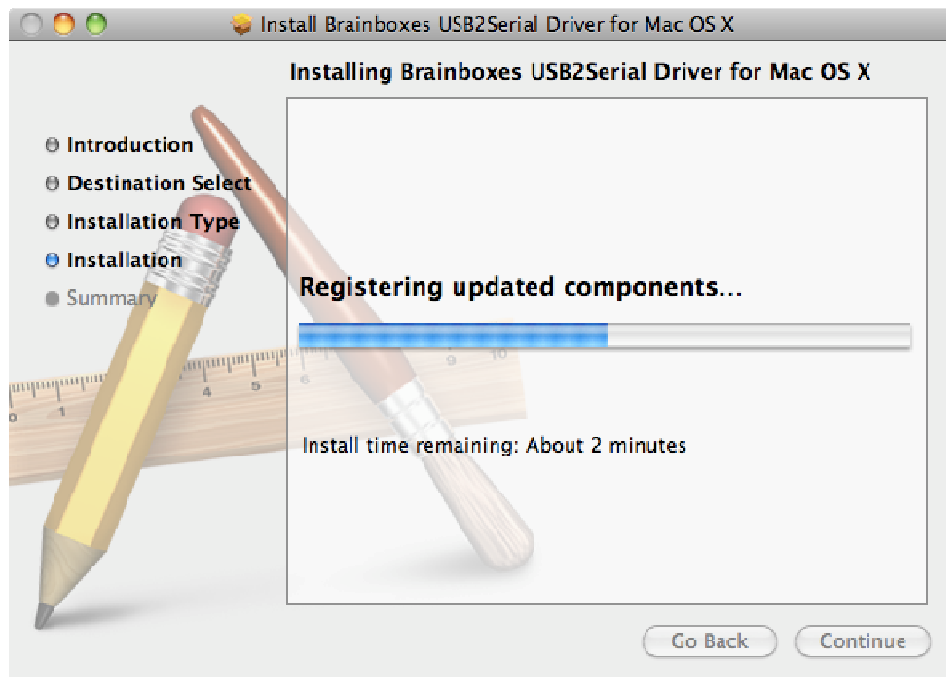

There will then be a message telling you that the installation was successful.

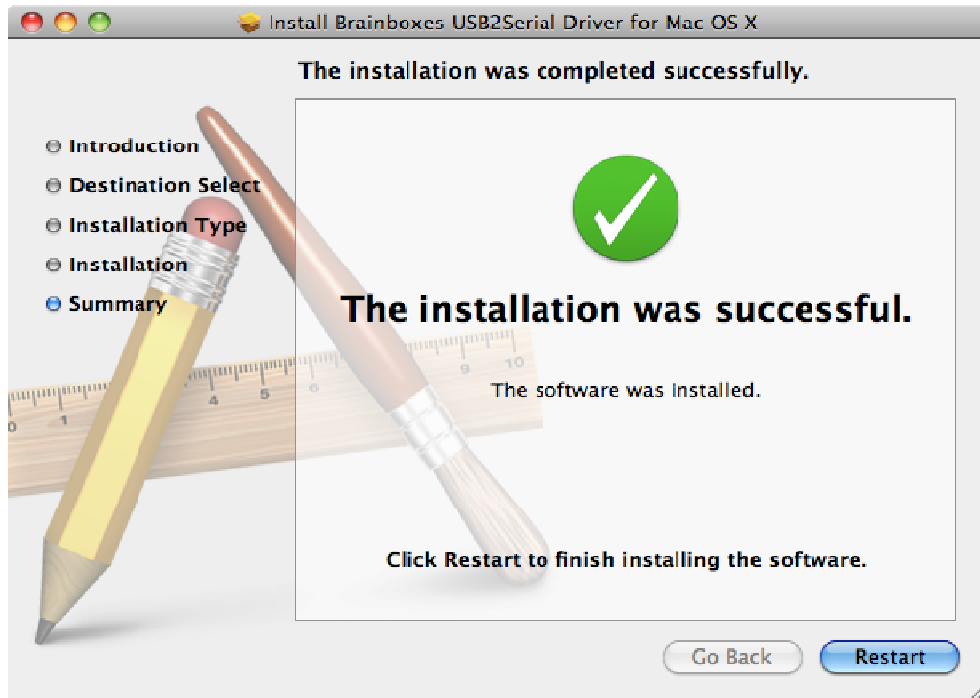

You will then need to restart to complete the driver installation.

## 2.3 Finding your Brainboxes COM port

- **Open** Device Manager (Found by Right Clicking on My Computer and clicking *Manage*. Then Select *Device Manager* from the left hand pane.)
- **Find** the Brainboxes Serial Port entry in Device manager. (Found under the '*Ports*' section)
- The Brainboxes Serial Port entry displays the current COM number in brackets after the name. (This is usually *COM3* following install, but may be different if other serial devices have been installed in the past)
- To change your COM label, see **Section 2.6: Changing your COM label**

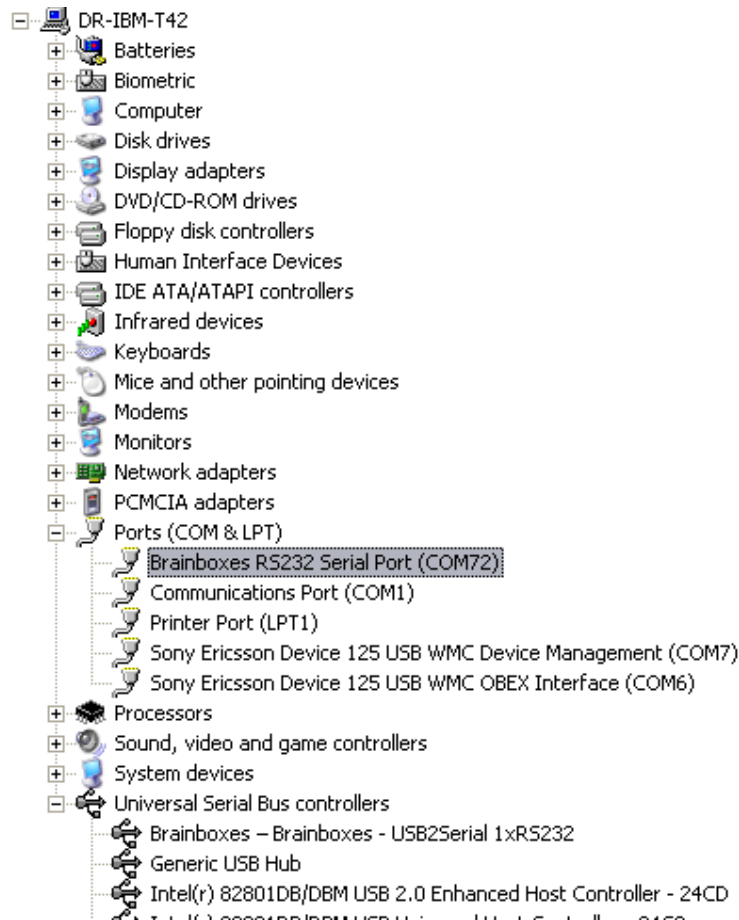

## 2.4 Port Settings

The Port Settings allow you to set Default or Override Settings for the serial communication and how to deal with incoming hardware handshaking events.

- To open '*Port Settings*', open device manager and **Double Click** on the Brainboxes COM Port Entry under the '*Ports*' section
- Then Click on the '*Port Settings*' tab.

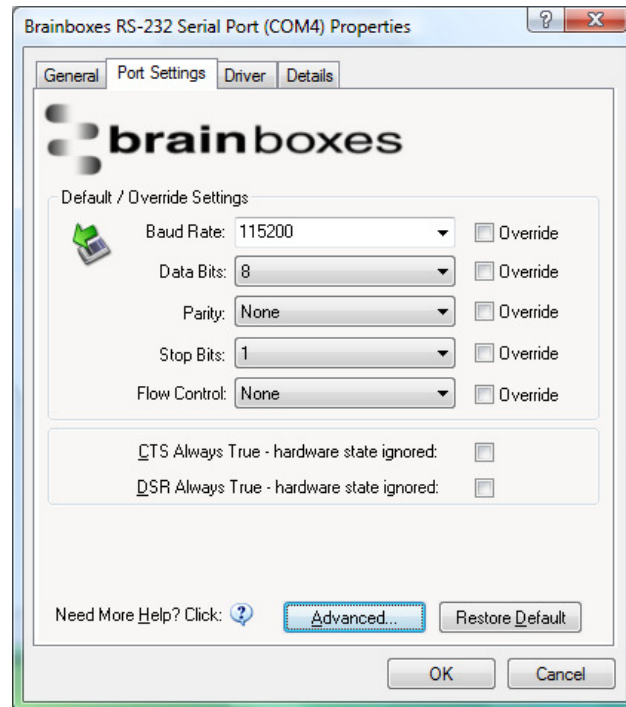

- All options can be selected from the Dropdown Menus. In addition, you can enter a non-standard value into the Baud rate

**NB** – Once the desired settings have been achieved, you must click **OK** to activate them. At any time click the ‘Restore Default’ button to return to the original setup.

### Default / Override Settings

- The “**Default Settings**” will be set if an application does not specify the serial settings when it opens the COM Port.
  - This is sometimes the case with old Legacy applications and you will need to choose these settings to match the communications that you wish to use.
  - The majority of Applications will specify what Serial Settings they wish to use. In this case, it will not matter what the Default settings are, as the Port will be opened with the Application’s Settings.
- When the ‘**Override**’ box is checked next to the Default Setting, the Port will communicate at this setting whether an application has requested it or not.
  - For example, this will enable you to force baud rates that your application does not allow you to select. This can be useful for interfacing to equipment which uses higher baud rates or unusual baud rates, which your application does not support.
  - In a case where you want to use hardware handshaking, but your application is not capable, you can select RTS / CTS Always True – Hardware state ignored and choose to Override it.
  - **NB** with the use of Override Settings, you need to ensure that the equipment you are connecting to be setup to match the communications settings you are forcing.

## CTS / DSR Always True

- CTS and DSR are incoming hardware handshaking lines. This means they receive signals from the connected device which tell the US Card when it is and isn't OK to send data.
  - Sometimes these signals may want to be ignored. By forcing CTS or DSR True, the US Card will ignore those signals and always send data.
  - These settings are especially helpful when CTS and DSR are not physically connected (such as in a 3 wire setup) and it is not acceptable for the data flow to stop and start due to arbitrary variances on the unconnected signal lines.

## 2.5 Changing your COM label

- If you need to change the COM label, **Double click** on the Port entry in Device Manager
- Click on the '*Port Settings*' tab and click **Advanced**

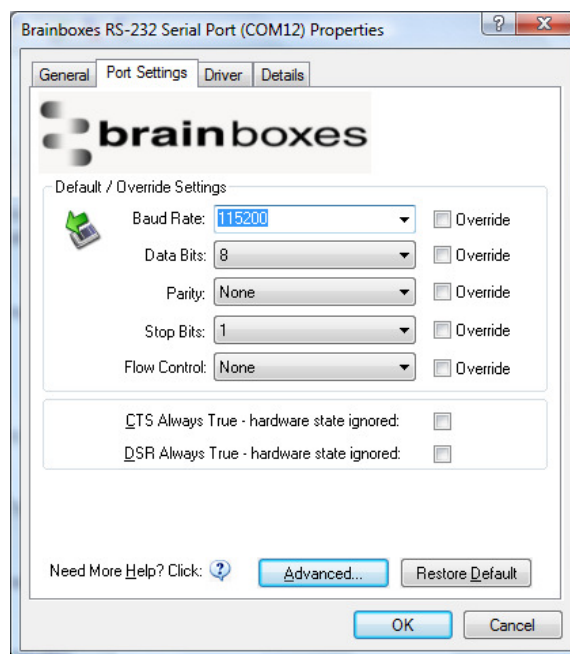

- A new COM Port label can be selected from the dropdown menu. Click **OK** to set the new COM Label.

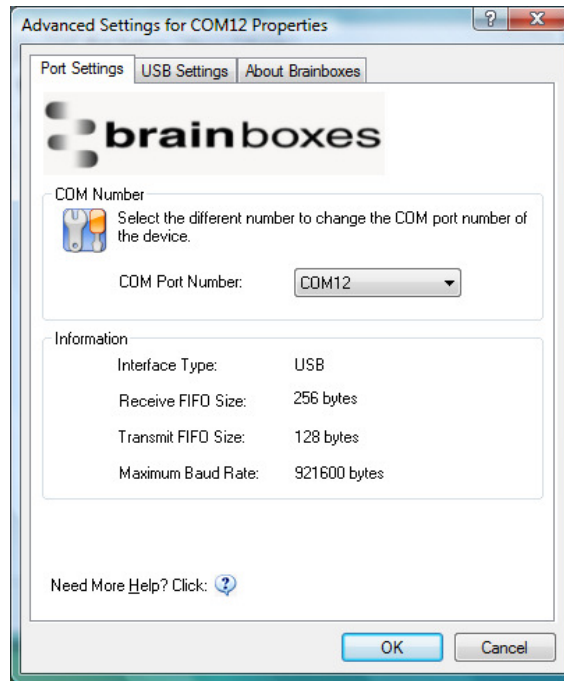

- If the COM Port number is labelled "*in use*", it is either currently used by a COM Port present on the system, or is reserved for a device which is not currently present. It is possible to select this COM number and force the change, if you are sure it is not required by any other device.

### 3. RS-232 Settings (US-101, US-235, US-257, US-279, US-701)

#### 3.1 The RS-232 Standard

The RS-232 standard was introduced in 1962, it is now widely established. RS-232 is a slow speed, short distance, single ended transmission system (i.e. only one wire per signal). Typical RS-232 maximum cable length is 50 feet.

#### 3.2 9 Pin D Serial Port RS-232 Cables

To connect to the RS-232 Serial Port you will need a cable terminating in a 9 way female D connector. It is sound practice to use cables with screws fitted that will allow you to fasten the cable securely to the PC card.

In general, you will need to make up a "cross-over" cable to correctly interface the PC to the RS-232 port of another computer or device. Provided you have the pin outs and handshake requirements of both sides of your RS-232 connection, the cross over cable becomes a matter of common sense. The cross-over cable is simply to ensure that the right signals going out of one RS-232 port go into the appropriate lines of the other RS-232 port.

#### 3.3 9 Pin D serial port connections to another PC.

SERIAL PORT Side

Other PC SERIAL PORT Side.

9 PIN D CONNECTOR

9 PIN D CONNECTOR

#### SCHEMATIC REPRESENTATION:

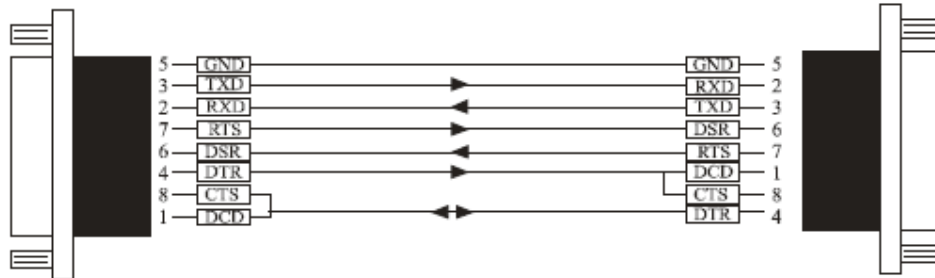

#### ACTUAL REPRESENTATION:

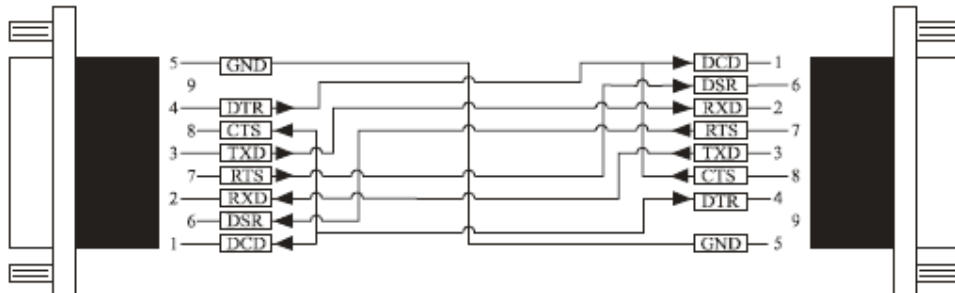

Suppose we want to connect the Brainboxes Serial Port to the serial port of another PC. Connect the earth lines. Line 5 of Serial Port 2, to lines 1 & 7 of the other PC. This gives the two devices a common earth level.

Connect the Transmit and Receive lines together. Line 3, TXD, Port 2 goes to line 3, RXD, of the other PC. Line 2, RXD, Port 2 goes to line 2, TXD, of the other PC. This allows each to receive the data transmitted by the other.

Connect the Port 2 DTR line, pin 4 to the other PC DCD, pin 8 and CTS, pin 5, lines. Also, connect up the other PC DTR line, pin 20 to the Port 2 DCD, pin 1 and CTS, pin 8, lines.

This allows the receiving device to signal when it can no longer accept data. The receiving device sets DTR false when it is unable to receive any more data. The sending device reads DTR on its CTS and DCD pins. It should stop sending when CTS goes false.

Connect the Port 2 RTS line, pin 7, to the other PC DSR line, pin 6. Also, connect the other PC RTS line, pin 4, to the Port 2 DSR line, pin 6. This RTS line is used to let the other device know that it is ready for data exchange.



#### 4. RS-422/485 Settings (US-320, US-324, US-313, US-346, and US-842 only)

- To achieve **RS-485 Half Duplex** Communications, using two wires for communication, Pins 1&6 and 2&7 must be physically shorted together.
- Once your wiring is setup, you will also need to set the card to FULL or HALF Duplex mode in the software.

For **RS-422/485 products only**, there is an additional tab in the Advanced Settings to allow you to change duplex mode.

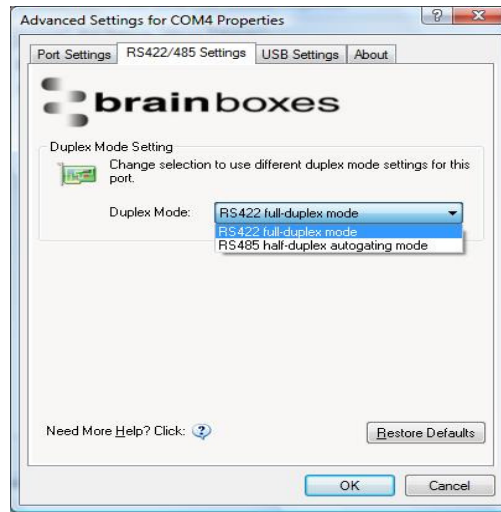

- The drop down list allows users to choose the desired RS-422/485 operations mode.
- Select “RS-422 full duplex mode” for Full Duplex communications.
- Select “RS-485 half duplex autogating mode” for Half Duplex communications.
- Restore Defaults: Pressing this button will reset all settings on this Property Page back to the factory defaults of this device. The default settings for this Property Page are “RS-422 full duplex mode”.

#### Background Information:

- DTR/DSR Handshaking is not available on 422/485 devices.
- The factory default RS-422/485 setting is full duplex mode.
- The RS-485 standard talks about the differential pair as ‘Data A’ and ‘Data B’ but line driver chip manufacturers use the labels ‘Data+’ and ‘Data-’.
- ‘Data A’ is the inverting pin ‘Data-’ and ‘Data B’ is the non-inverting pin ‘Data+’
- If you can’t get the connection to work it may be because you have mistakenly connected the lines the wrong way round.

#### 4.1 The RS-422 Standard

The RS-422 standard defines a serial communications standard. RS-422 is a high speed and/or long distance data transmission. Each signal is carried by a pair of wires and is thus a differential data transmission system. Over distances up to 40 feet the maximum data rate is 10 Megabits per second, and for distances up to 4000 feet the maximum data rate is 100 Kilobytes per second. A 120-Ohm resistor should be used to terminate the receiving end of the line. It is generally used between one transmitter receiver pair to ONLY one other transmitter receiver pair, but each output can drive up to 10 receivers.

RS-422 Standard - 1 Driver up to 10 Receivers	
Line Length	Max Data Rate
40 Feet = 12m	10 Mbits/sec
400 Feet = 122m	1 Mbits/sec
4000 Feet = 1219m	100 Kbits/sec



#### 4.2 The RS-485 Standard

The RS-485 standard is similar to the RS-422 standard upon which it is based. The main difference is that up to 32 transmitter receiver pairs may be present on the line at one time. A 120-Ohm resistor should be used to terminate either end of the main line. If more than one device may transmit data, the RTS line is used as transmit enable signal, so preventing contention between talkers.

RS-485 Standard - Up to 32 Driver/Receiver Pairs	
Line Length	Max Data Rate
40 Feet = 12m	10 Mbits/sec
400 Feet = 122m	1 Mbits/sec
4000 Feet = 1219m	100 Kbits/sec

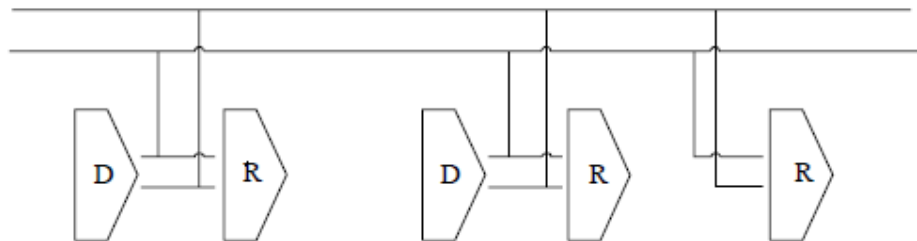

### 4.3 Terminating Impedances

RS-422 and RS-485 lines should be terminated at the end of the main branch of the RECEIVER, in the cables characteristic impedance. These terminating impedance's stop echoes caused by the serial data being reflected back at the cable ends. It is not necessary to terminate the transmitter end of the twisted pair.

Brainboxes cards have the correct 120 Ohm (nominal) terminating resistors for the RXD twisted pair line and the CTS twisted pair line fitted on the RS-422/485 card for the serial ports on the card.

There is no need to add any more at the PC end.

The terminating impedance's shown later in the wiring diagrams are automatically provided by the on board resistors and do not have to be added by the user.

This RS-422/485 termination circuit is based on the recommendation of Texas Instruments, and uses resistors to provide line termination  $R_t$ , bus-idle failsafing (biasing)  $R_b$  and bus-shorted failsafing,  $R_f$ . However, this circuit may not be suitable for all RS-485 bus systems. Whilst the circuit includes line termination to prevent the data signal being reflected, this termination should only be present at each end of a bus and not at any intermediate nodes. Also, while this circuit ensures that our US devices are properly biased when the bus is idle, this circuit may not provide sufficient bias for any nodes (i.e. external RS-485 devices) which have their receivers connected directly to the D+ and D- lines. If you do have RS-485 devices whose receivers are connected directly to the D+ and D- lines, you may need to add a couple of resistors to your bus, from D- to ground and from D+ to a positive supply, with a resistance sufficient to give at least 0.2V between D+ and D- when the bus is idle.

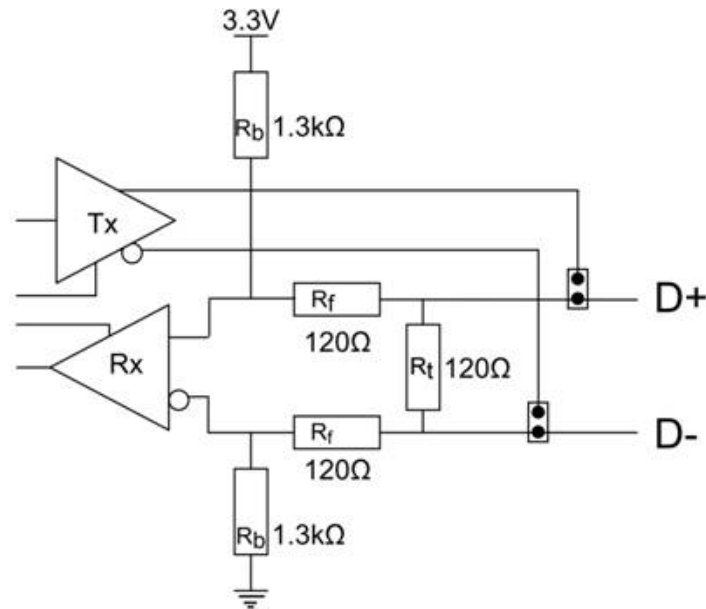

#### 4.4 Fail Safe Open Circuit Detection

Open circuit is when there are no drivers on the circuit. This occurs by design in party line multi driver/receiver systems and unintentionally when the twisted pair line is accidentally cut or disconnected or the transmitting device fails. In RS-485 party line systems there are extended periods of time when none of the many possible talkers are gated onto the bus. This is known as the line idle state and occurs when all the driver outputs are in the high impedance state. The lines float, perhaps being pulled to the high or low state by noise or other voltages on the line. Without fail safe open circuit detection false start bits are detected by the receivers, either corrupting good communications or causing noise to masquerade as good data. The on board fail safe open circuit detection causes the receiver to go to a known, predetermined state and prevents false start bits and bad data being detected during open circuits.

#### 4.5 Fail Safe Short Circuit Detection

Short circuits are when the two lines of a twisted pair are connected together. This occurs due to either accidental damage to the cable or due to failure of one or more transmitter/receivers on the line. The short circuit condition is dangerous since damage to the receiver may occur and communication may be corrupted or prevented. The on board fail safe short circuit detection prevents the line impedance from going to zero and thus protects the inputs of receivers and the outputs of drivers.

#### 4.6 RS-422 Operation

Generally, in RS-422 systems all 8 signal lines from the 9 pin D connector participate in the data transfer sequence, thus 4 twisted pair cables are used. One twisted pair carries the TXD data outwards, one pair brings the RXD data inward, another pair carries the RTS handshake outwards and the fourth pair brings the CTS handshake inwards. There is no need to carry the ground from one device to another. This RS-422 arrangement allows data to be transmitted and received simultaneously since each signal has its own data cable pair. In addition, the receiver can set RTS true so telling the transmitter on its CTS input that the receiver is ready to accept data. In this way, no data will ever be transmitted when the receiver is unable to accept it, due to a full input buffer etc. And so no data will be lost.

#### 4.7 RS-485 Operation

The RS-485 standard is intended for up to 32 driver receiver pairs on the bus. The line drivers used in the RS-422/485 card are designed to work correctly in both RS-422 and RS-485 systems. The main difference therefore is in how the system is implemented. Though the card uses a 9 pin D connector, in general, not all the lines are used for RS-485 systems. The RTS+/- and CTS+/- lines, though driven by the card, are usually not connected. In two wire, Half-Duplex configurations the TXD+ line is connected to the RXD+ whilst the TXD- line is connected to the RXD-, only one pair of twisted wire cable is used in RS-485 Half Duplex communications. The hardware handshaking performed by the CTS+/- and RTS+/- lines in RS-422 systems are handled by a software protocol in RS-485 systems. In situations where more than one device may transmit data on the shared data line, each cards RTS line is used as a gating signal to enable the TXD driver only when that card needs to transmit data. This mechanism prevents bus contention caused by multiple transmitters holding the line in opposing states. Our cards have a facility which automatically “gates” the RTS line, thus enabling the transmitter independently of any software. The three wiring schemes given described below are: -

1. RS-485 One Talker Many Listeners (HALF DUPLEX)
2. RS-485 Many Talkers Many Listeners (HALF DUPLEX.)
3. RS-485 Many Talkers Many Listeners (FULL DUPLEX.)

### RS-485 One Talker - Many Listeners, Half Duplex.

There are several schemes for connecting RS-485 devices depending on the characteristics of the system. In many cases there will be only one device, which can transmit, data and all the others simply listen to it. This scheme is used for theatrical lighting intensity control in the DMX512 standard. This is shown below. There is NO multiplexing of the TXD and RXD lines. Data is only flowing one way, from PC outwards, and is thus a Half-Duplex configuration; only one twisted pair cable is needed.

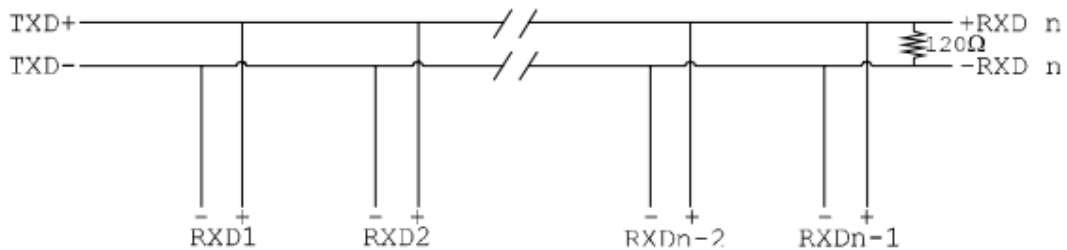

Note: The Receiver end of MAIN line terminated in characteristic impedance by ONBOARD resistor networks stubs off the main not terminated. In the above scheme, one RS-485 device is talk only, it transmits data, but it does not receive any. The other RS-485 devices are received only; they do not transmit any data at all.

### RS-485 Many Talkers- Many Listeners, Half Duplex.

Another popular RS-485 layout is for multiple talkers and multiple listeners. This is shown below. This is also known as "party line" transmission. It is imperative to have some method of preventing two devices trying to drive the data lines at the same time. The normal method is to use the RTS line as a talk enable. The RTS line should go true immediately prior to the data transmission and go false immediately after the last byte in the stream is sent.

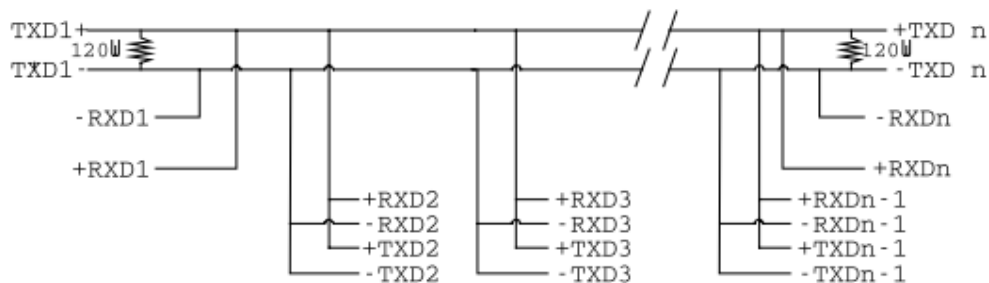

Note: BOTH ends of MAIN line terminated in characteristic impedance, stubs off main line not impedance, since both ends receive. The twisted pair ends are wired to both RXD+ & TXD+ and RXD- & TXD- at each RS-485 device!

### RS-485 Many Talkers- Many Listeners, Full Duplex.

RS-485 devices have separate Transmit and Receive channels. There is NO multiplexing of the TXD and RXD signals on the same device. This system is especially useful when there is no flow control available on the PC, usually due to the use of a third party communications program that prevents the use of the RTS signal as a "transmit enable" control. It can be used in the following situations:-

- a) The PC is connected to only ONE RS-485 device.
- b) The PC is communicating with several RS-485 devices that are each able to recognize and respond to their own unique address. The RS-485 devices only drive their TXD lines when they are responding to requests from the PC to send data. In effect, the RS-485 device's address and the command it receives is used to control access to the devices TXD channel.

This is a Full Duplex system. Two twisted pair cables are required. One twisted pair, is the PC's TXD channel, it carries the data sent from the PC's TXD outputs to the RXD inputs of each of the RS-485 devices. The second twisted pair, is the Devices TXD channel, it carries the data sent from each of the devices' TXD outputs to the RXD inputs of the PC. The advantages of this system are great, since no new communications, software is needed, and the PC can talk and listen at the same time. In effect, the handshaking is performed by the intelligence of the RS-485 devices attached to the PC. When wired as below, the PC can transmit data at any time and all the RS-485 devices #1 to #n simultaneously receive it. Only one of the RS-485 devices may talk, i.e. transmit data, at any one time. Each RS-485 device recognizes commands and data addressed to it; it only talks when the PC commands it to do so. When the RS-485 device receives the command to talk from the PC, it gates its TXD drivers on, sends the data down the device TXD channel, and disables its TXD drivers. The other RS-485 devices remain in the 'receive only' mode when they are not being addressed, they do not transmit any data at all.

### RS485 Full Duplex.

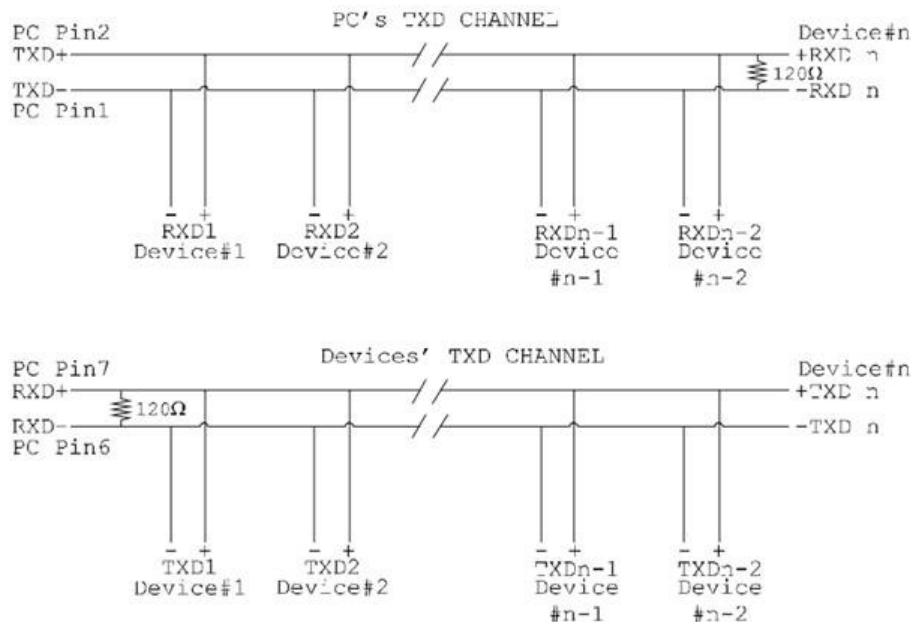

Note: The receiver end of MAIN line terminated in characteristic impedance, stubs off the main not terminated.

#### 4.8 RS-422 Serial Port Cables

Use screened twisted pair Belden cable 9729 and 9829, L type 2493 and 2919 cable to make the RS-422 connection. Unscreened Belden type 8795 may also be used in less noisy environments. The on board resistor networks terminate the receiving end of the twisted pair cable in its characteristic impedance.

#### 4.9 RS-485 Serial Port Cables

For best noise immunity use twisted pair cables to make the RS-485 connection. In Half Duplex wiring only 1 twisted cable pair is needed. Two twisted pair cables are needed for Full Duplex communications. Use screened twisted pair Belden cable 9729 and 9829, UL type 2493 and 2919 cable to make the RS-485 connection. Terminate the twisted pair cable.

#### 4.10 Optional Grounding Arrangements

Proper operation of the cable circuit, according to TIA EIA: 485 A (1995) requires that the cable ground shield is not connected directly to the equipment ground shield. A current limiting resistor should be used in series with the shield to avoid possible large current flow due to differences in ground potential. Any one of the methods shown below can do this.

The circuit common of the equipment is connected to protective ground, at one point only by a 100 Ω, ±20% resistor with a power dissipation rating of 1/2W. An additional provision may be made for the resistor to be bypassed with a strap to connect signal common and protective ground directly together when specific installation conditions necessitate.

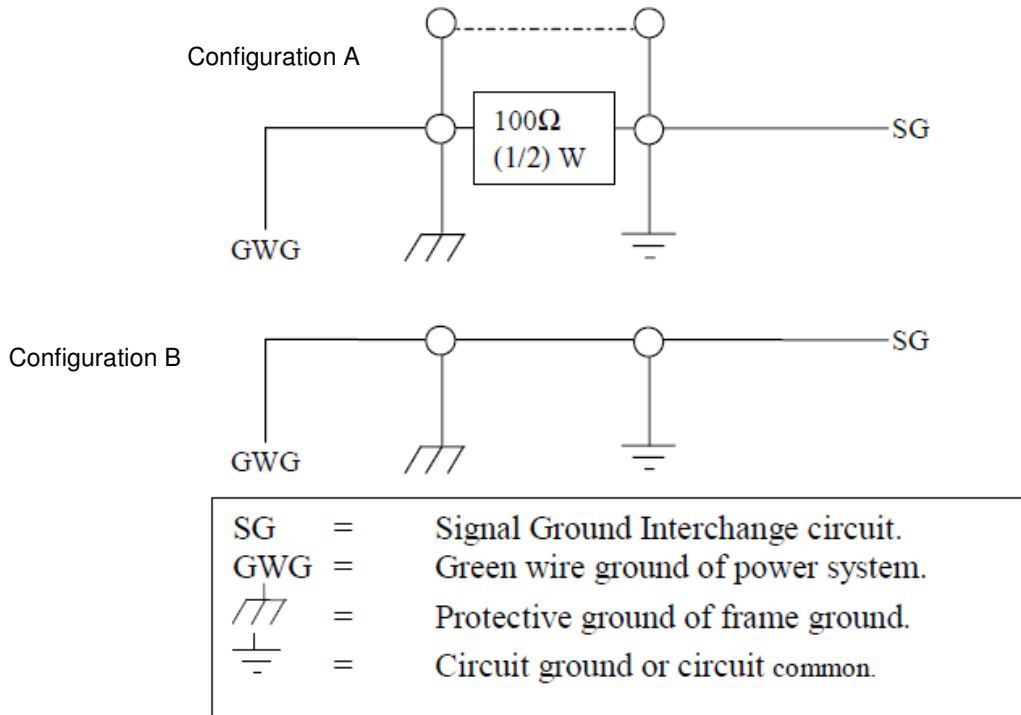

## 5. Advanced Settings – USB Settings

The Advanced USB Settings for the Brainboxes COM Port allow you to get the best performance from your device and system. There are two choices, dependant on whether minimal CPU usage or Data Latency (delay) is the main concern.

The default settings have been carefully selected and should provide great performance for the majority of users. The USB Settings will help if you need to lower the CPU usage, or your application is timing critical and requires a lower Data Latency

- To open Advanced Settings, open the Port Settings (as described in section 2.5) and click the **Advanced** button.
- **Select** the '*USB Settings*' tab.

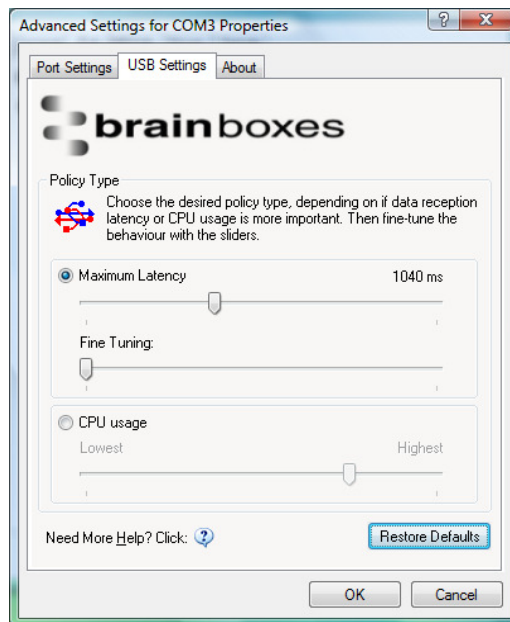

**NB** – Once the desired settings have been achieved, you must click **OK** to activate them. At any time click the '*Restore Default*' button to return to the original setup.

### Maximum Latency

- Maximum Latency will allow you to choose the maximum time taken for received data at the 9 Pin connector of the port to be processed and passed to the Application.
- The slider is non-linear, which allows settings for small latencies to be adjusted more accurately than those for larger latency values, where accuracy is less important.
- **NB** – The maximum latency value cannot be guaranteed on all systems. Only drivers on Real-Time Operating Systems can guarantee latency times. Due to technical limitations, for baud rates below 1200 baud and maximum latency settings below 45ms, the actual latency will be higher than expected.



- The Fine tuning slider may be useful to obtain the best performance whether your application is sending small bursts of information, or is continuously streaming the data.
- This slider will allow tuning the behaviour to suit the needs of the specific application. While maintaining the Maximum Latency value chosen above, smoothness of data reception and CPU usage can be improved by choosing the best fine tuning option.
- Data reception behaviour is very different when comparing reception of continuous streaming data without gaps to the reception of 'occasional' data - data with gaps in the data stream.
- **NB** – There is no quantitative value attached to this slider. To find the optimum value, trial and error is required.

### CPU Usage

- Selecting the CPU Usage radio button and moving the slider to the left-most position will give the lowest CPU Usage behaviour, saving your CPU clock cycles for other processing. Nevertheless, the impact on latency and smooth data flow might be too severe.
- To lessen the impact, change this slider until optimum system behaviour is achieved. CPU Usage will increase the further the slider is moved to the right.
- **NB** – There is no quantitative value attached to this slider. To find the optimum value, trial and error is required.

## 6. Uninstallation

You can uninstall the Brainboxes Boost.Software drivers at any time, with or without the Card inserted into the Laptop. The un-installation steps below are applicable to all cards in the US range.

### 6.1 Uninstalling in Windows XP

- **Open** Control Panel, and then open *“Add or Remove Programs”*
- **Click** on the *“Brainboxes Boost.Software Device Driver Suite”* and then click **Change/Remove**
- The Brainboxes Boost.Software installer will launch. Please see **Section 6.3: Brainboxes Boost.Software Uninstaller**

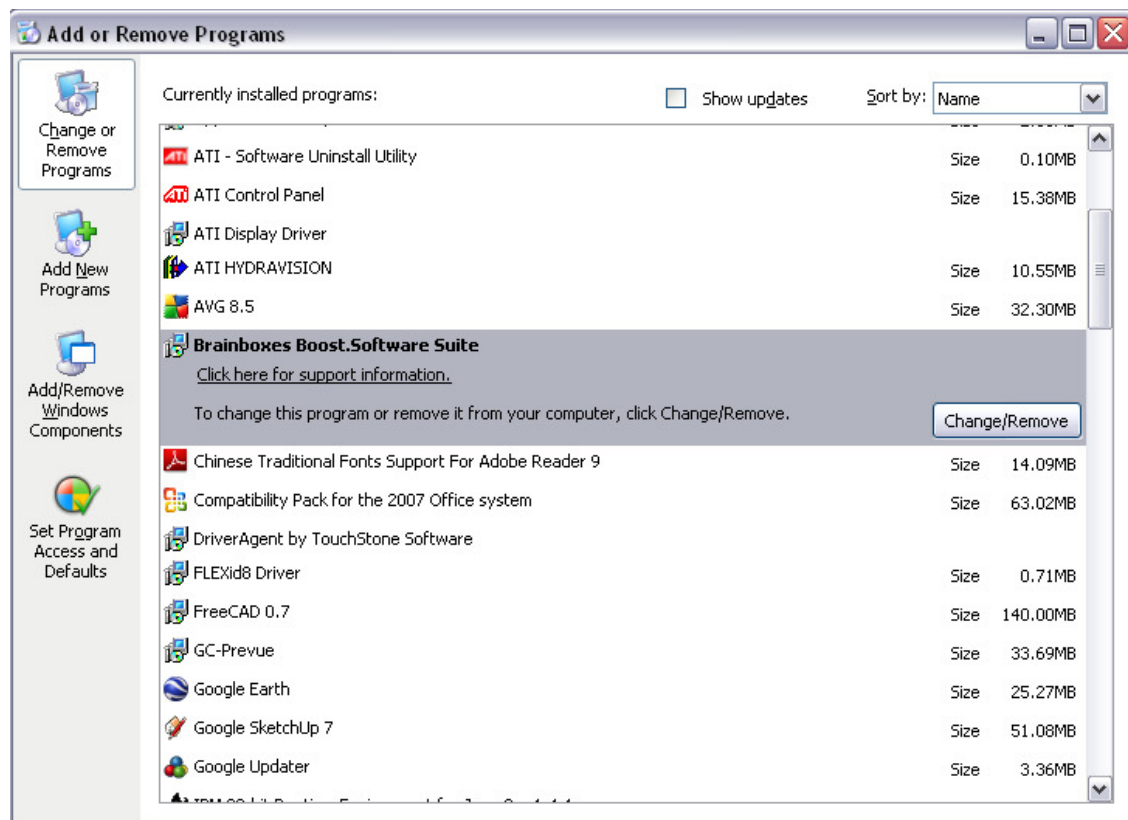

### 6.2 Uninstalling in Windows Vista / Windows 7

- **Open** Control Panel, and then open *“Programs and Features”*
- **Click** on the *“Brainboxes Boost Software.Suite”* and then click **Uninstall/Change**
- The Brainboxes Boost.USB installer will launch. Please see **Section 6.3: Brainboxes Boost.Software Uninstaller**

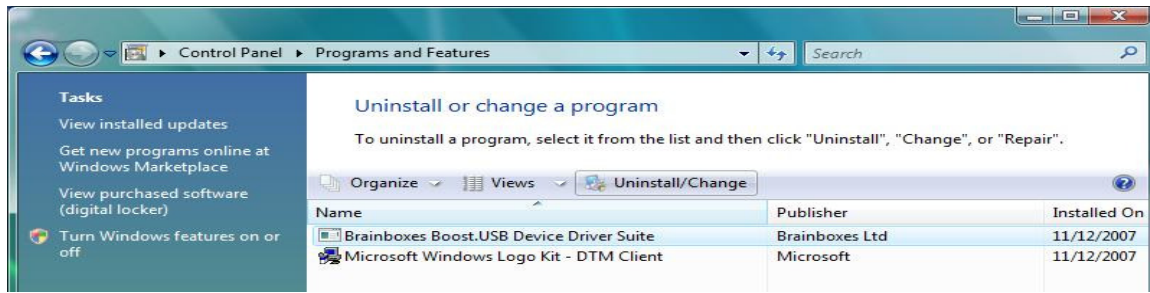

### 6.3 Boost.Software Uninstaller

- The Brainboxes Uninstallation wizard will launch which will remove all driver files and associated registry entries. Just click **Next** on each page of the Wizard. When the drivers have been uninstalled, click **Finish**.

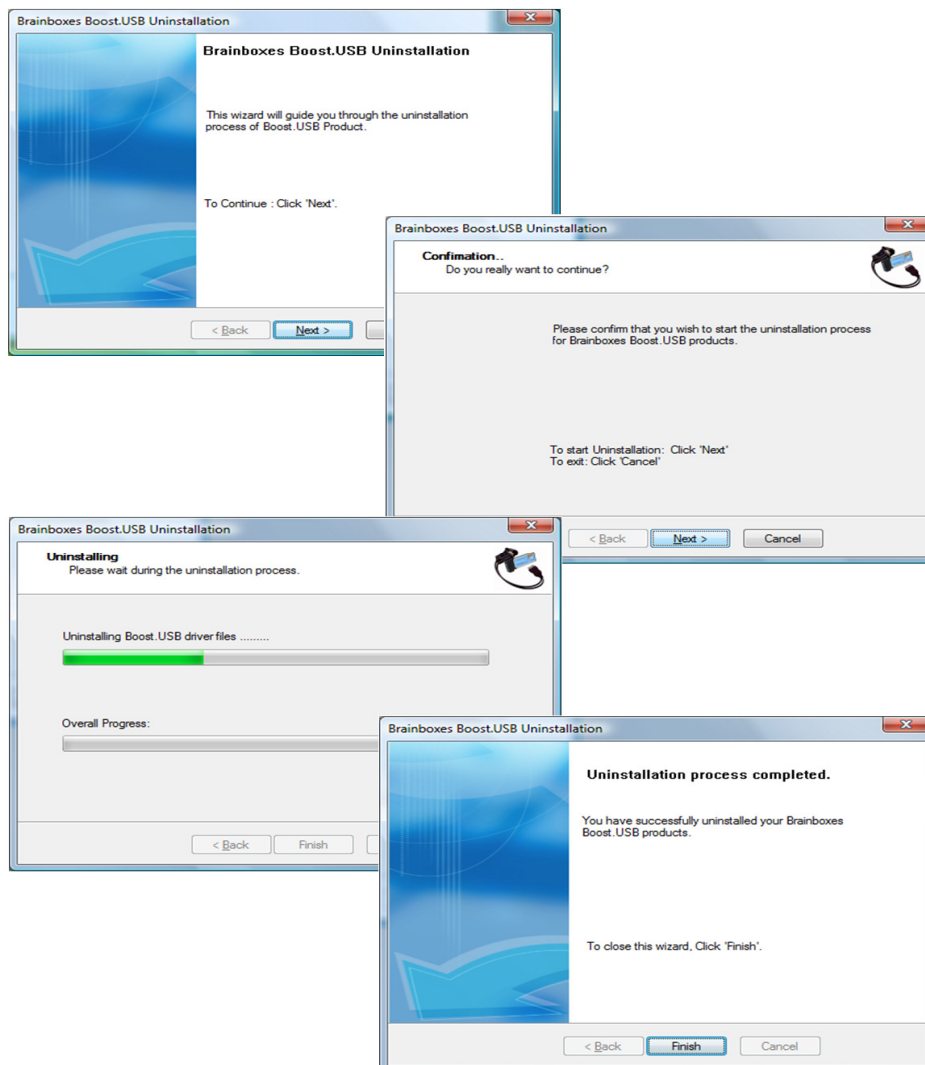

- When finished, you may unplug your US Card. To reinstall, simply plug in the card again and follow the installation instructions as in Section 2: Installation Instructions.

## 7. Boost.Software US Card Driver Upgrade / Rollback

There are two parts to the Boost.Software, US Range driver:

(Taking for example the US-101 1 Port RS-232 Device)

- Card driver: “Brainboxes – Brainboxes - USB2Serial 1xRS-232”
- Port driver: “Brainboxes RS-232 Serial Port (COM3)”.

**NB** If you need to upgrade or roll back the Boost.Software driver, we recommend to completely uninstall the existing drivers first, and then to install the new drivers from fresh. This will restore all settings to factory default. However, if you instead wish to retain your settings, you can use the ‘Update Driver’ or ‘Rollback’ in Device Manager for upgrading/rolling back the US Card driver.

### 7.1 Upgrading the Boost.Software Driver

1. Go to Device Manager and Right Click on the USB2Serial entry (Found under Universal Serial Bus Controllers – see image below)

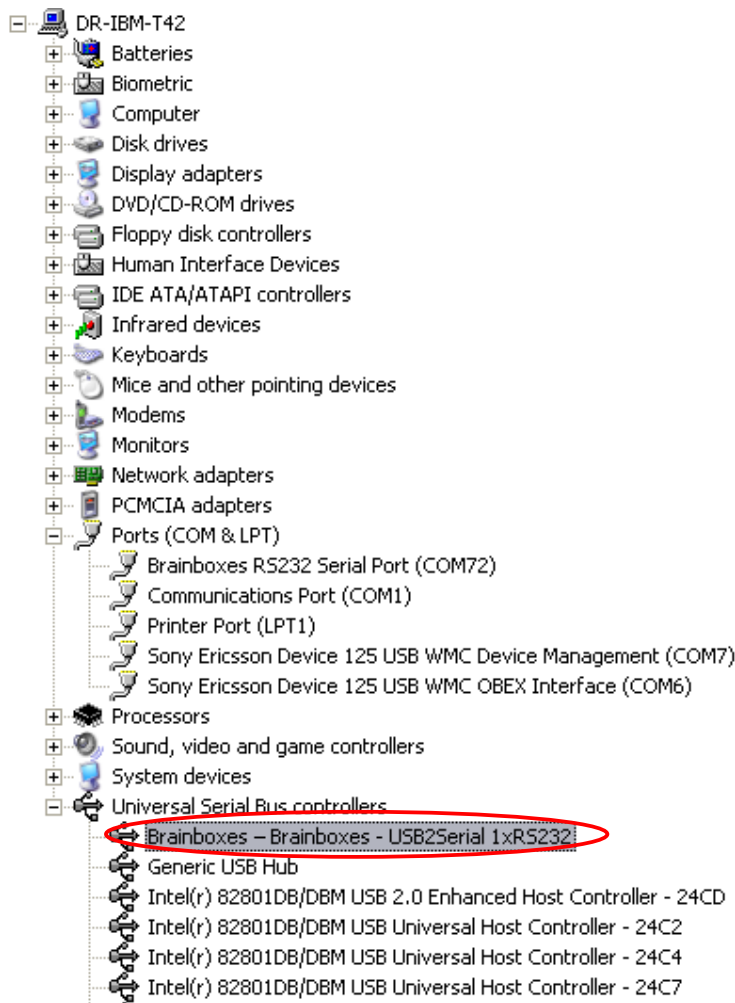

2. Select Upgrade Driver. This will launch the Found New Hardware Wizard. Follow the on screen instructions.

NB: It is only possible to upgrade the Boost.Software driver via the Serial Card entry in Device Manager and not the Serial Port entry. The upgrade process will automatically upgrade the Port driver.

## 8. Troubleshooting and Testing

### 8.1 Installation problems

- Check the US Card is correctly installed, and the Ports appear in Device Manager without any errors (Errors are indicted by a yellow exclamation mark)
- If the installation did not complete or shows any error messages then restarting the computer sometimes helps.
- If Device Manager is still showing error messages, it is wise to uninstall and re-install. This should cure issues such as Resource Conflicts or failed installations. See **Section 6: Uninstallation and Section 2: Installation Instructions**.
- If the problem is still present after trying the above, try another laptop to narrow down the problem.
- Should the problem still persist, please contact [Brainboxes Technical Support](#)

### 8.2 Communication Problems

If you are experiencing communication problems:

- Try removing the card and reinserting as this can sometimes help.
- Check the US card is correctly installed and the Ports appear in Device Manager without any errors (Errors are indicted by a yellow exclamation mark).
- Perform a loopback: A loopback test will confirm that your card is able to Transmit and Receive Data. The Transmit and Receive lines will need to be connected so that any data sent out of the card is then received back on the same Port. Please use the Brainboxes Loopback Test Application to perform a loopback test. [Click here to Launch Loopback test](#)
- If a loopback test passes, please contact [Brainboxes Technical Support](#)

## 9. Lifetime Warranty and Support

To receive the lifetime Warranty, you need to register your product with us using our online form.

**NB: this must be done within 28 days of Purchase.**



[Lifetime Warranty Sign up](#)

\* Terms and Conditions are available online. Standard warranty period is 3 years if a product is not registered.



Since 1983, Brainboxes have designed, tested and manufactured our products all under one Roof. One of our greatest strengths is in after sales service. Technical Support is provided by members of our Test Team, who know our products inside out and have direct access to the chip and board designers as well as the technicians who built and tested your product.

If you have any issues, questions or suggestions about our Products and Services, then please contact us.

Technical Support is free\*. As long as you have a Brainboxes Product we will be happy to help, even if it's discontinued or out of warranty. Excellent Customer Service, just as it should be.

For the quickest solution to your issue, if you email us, please include as much detail of your setup and the fault you are experiencing.

\* Standard rate call charges for phone support apply.

### Email

Technical Support: [support@brainboxes.com](mailto:support@brainboxes.com)

Sales Enquiries: [sales@brainboxes.com](mailto:sales@brainboxes.com)

### Telephone

You can speak to Brainboxes Support or Sales teams direct,

**Monday – Friday, 9am to 5pm (UK time)**

Tel: +44 (0)151 220 2500

## 10. Technical Specifications

### 10.1 Supported Serial Settings

Serial Setting	
Baud Rate	300 to 921,600
Data Bits	7 or 8
Parity	None, Odd, Even, Mark & Space
Stop Bits	1 or 2
Handshaking	RTS/CTS DTR/DSR Xon/Xoff
Break	Supported

### 10.2 Device Pinout

RS-232 Devices (US-101, US-257, US-701, US-279)

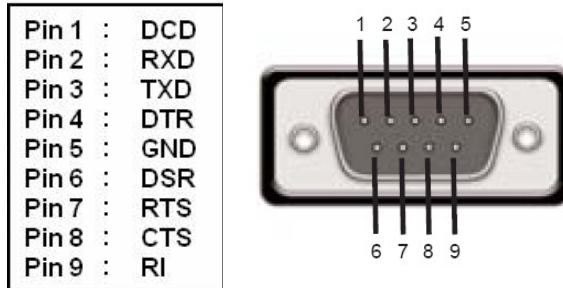

RS-422/485 Devices (US-324, US-313, US-346, US-842)

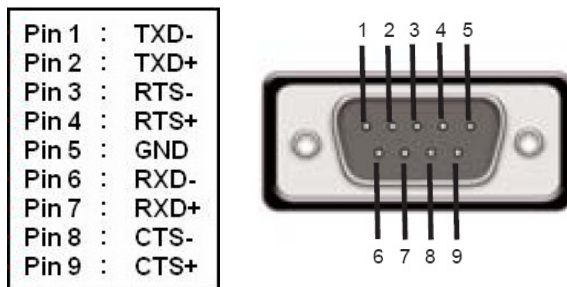

#### PLEASE NOTE:

- DTR/DSR Handshaking is not available on RS-422/485 devices
- For **RS-422 FULL Duplex** Communications, please note the pin outs above.
- To achieve **RS-485 Half Duplex** Communications, using two wires for communication, Pins 1 and 6 must be shorted together, and pins 2 and 7 must be physically shorted together.
- Once your wiring is setup, you will also need to set the card to FULL or HALF Duplex mode in the software.

### 10.3 USB Connector Pinouts

USB Type A connector (US-101 and US-324):

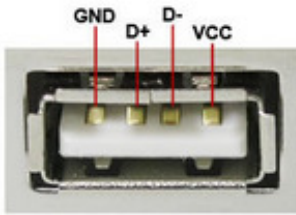

1	VBUS	Red
2	D-	White
3	D+	Green
4	GND	Black
Shell	Shield	Connector Shell

USB Type B connector (US-257/313/701/279/346/842):

USB Type B Socket

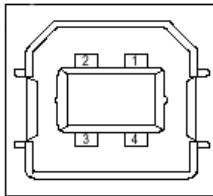

1=Vbus (5V)

2=D-

3=D+

4=GND



### 10.4 Storage and Operating Environment Guidelines

#### Storage

Temperature:  $-10^{\circ}\text{C}$  to  $+70^{\circ}\text{C}$

Humidity: 8% to 95% non-condensing

#### Operational

Temperature:  $0^{\circ}\text{C}$  to  $+70^{\circ}\text{C}$

Humidity: 20% to 75% non-condensing

### 10.5 RS-422/485 bias/terminating resistors - applicable to US-324/313/346/842 only

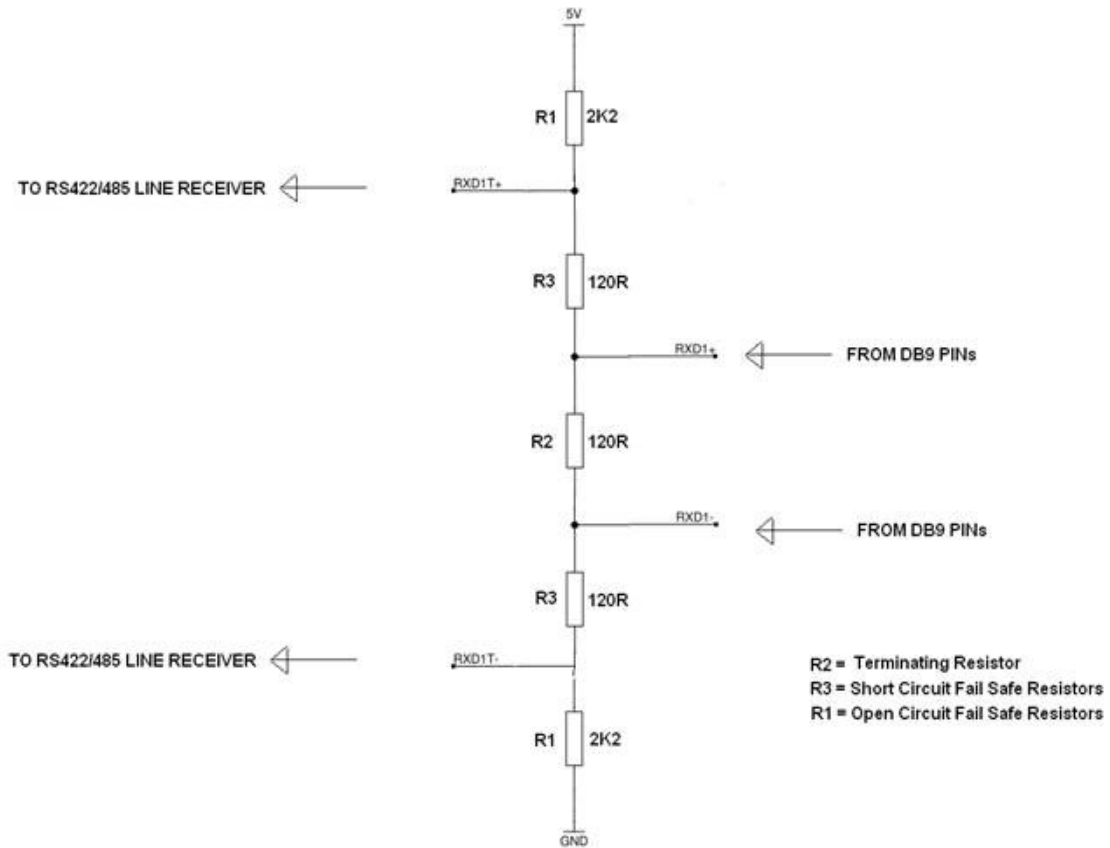

## 11. Regulatory Approvals / Compliance

For up to date details of global certifications, please check the product datasheet on the Brainboxes website: [www.brainboxes.com](http://www.brainboxes.com)

### 11.1 Company Accreditation

Brainboxes is accredited to internationally recognised standards for our Quality and Environmental Management Systems. Our ISO9001 Quality System was first accredited in 1994, followed by our ISO14001 Environmental System in 2008. These standards help ensure we can demonstrate effective management of all our quality systems and our environmental impacts, together with a process of continuous improvement.

All our Quality systems are subject to internal and external assessment on a regular basis. Copies of Certificates are available for download from our website: [www.brainboxes.com](http://www.brainboxes.com)

Linked with our Lean and Six Sigma techniques, we believe we have the most reliable products on the market, and to back this up we are offering a Lifetime Warranty\* on all our Serial Products.

### 11.2 Europe – EU Declaration of Conformity

Brainboxes products are designed to conform to the protection requirements of European Council Directive 2004/108/EC and its subsequent revisions.

A Declaration of Conformity and supporting Technical Construction File is available by request from Brainboxes, and will identify any updated legislation that may have been introduced since the publication of this Manual.

**Warning:** This is a Class A Product. In a domestic environment this product may cause interference in which case the user may be required to take adequate measures to address this.

### 11.3 WEEE Directive (Waste Electrical and Electronic Equipment)

The Waste Electric and Electronic Equipment (WEEE) Regulations 2013 became law in the UK on the 1st of January 2014 and replaced the 2006 Regulations. Brainboxes is fully compliant with this legislation.

#### Customer Responsibilities

You are encouraged to dispose of WEEE in an environment friendly way.

This can be done through your local civic amenities site, an approved treatment facility or alternatively through a relevant compliance scheme.

#### Brainboxes' Responsibilities

Brainboxes has a legal responsibility, as producer, to provide a free of charge collection service to our customers for our obligated WEEE.

Brainboxes is defined as a producer under the WEEE regulations because we sell own brand Electrical & Electronic Equipment (EEE) in the UK. Our WEEE Producer Registration Number is WEE/AH0004XR.

For details of our WEEE recovery service options, please see our Website, or email us at:

[weeerecovery@Brainboxes.com](mailto:weeerecovery@Brainboxes.com)

## 11.4 RoHS Compliance

All Brainboxes Serial and Bluetooth products are fully RoHS compliant.

Brainboxes identified at an early stage the importance of rapid compliance to RoHS guidelines and established a project team to actively manage the transition. The initial step in the process was to use our close relationships with suppliers to ensure early access to RoHS compliant components for all of our Bluetooth and Serial Products. In addition, the project team worked to ensure that our manufacturing processes meet all RoHS requirements well in advance of the deadline.



To verify supplier declarations on RoHS compliancy, we have also sent fully built products to an external test house for X-Ray system XDAL. This technique is capable of determining percentages of different elements and is accurate to 0.1% Wt.

RoHS Compliant Brainboxes products have been available since January 2005.

### What is the RoHS Directive?

The Restriction of the Use of Certain Hazardous Substances (RoHS) in Electrical and Electronic Equipment (EEE) Directive ([2011/65/EU](#)) was transposed into UK law on 2 January 2013.

This legislation bans the placing on the EU market of new EEE containing more than the agreed levels of:

- lead (Pb)
- cadmium (Cd)
- mercury (Hg)
- hexavalent chromium (Cr6+)
- polybrominated biphenyls (PBB)
- polybrominated diphenyl ethers (PBDE)

Any future revisions to this legislation will be complied with, and identified in a Declaration of Conformity, available on request.

## 12. Copyright

### **Copyright © Brainboxes Ltd**

All rights reserved. No part of this hardware, circuitry or manual may be duplicated, copied, transmitted or reproduced in any way without the prior consent of the Manufacturer.